

屋内照明器具特性

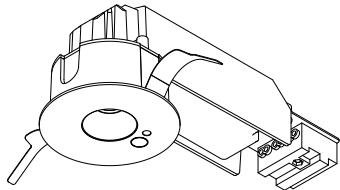

品名	DD-3487-LL		
光源	LED7.2W		
実効光束 (器具光束)	437lm	効率	60.7lm/W



配光曲線図

実光度

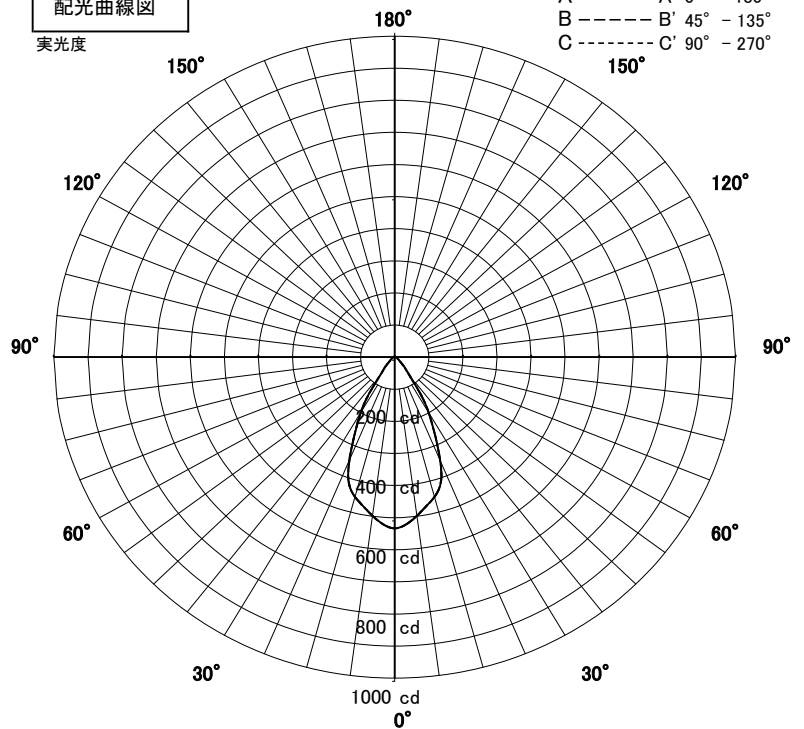

1/2照度角

直射水平面照度

単位: Lx

色温度	3000K	
演色評価指数	Ra83	
保守率	良	0.67
	中	0.63
	否	0.56

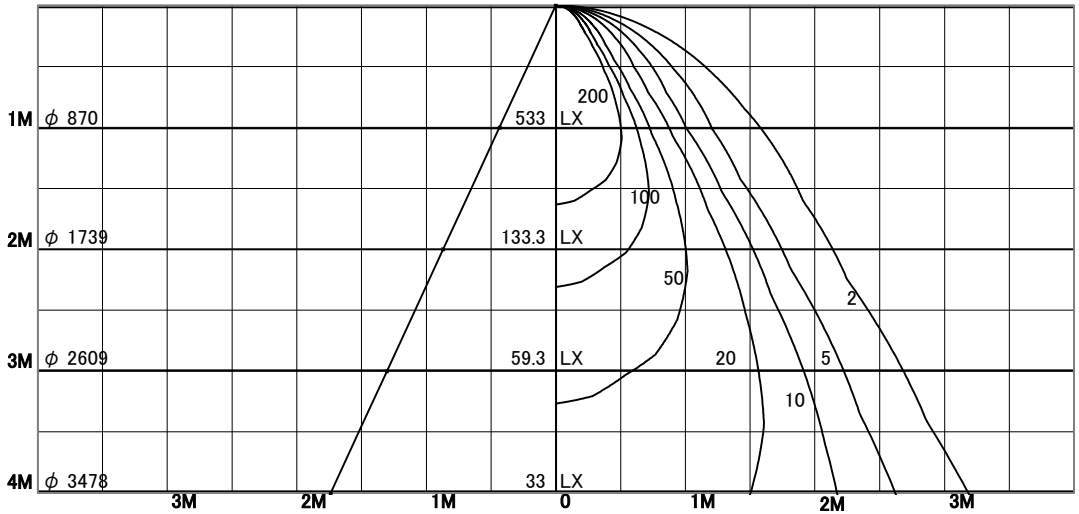

1/2照度角		
A-A'	47.0	Deg
C-C'	47.0	Deg
最大取付間隔		
A-A'	0.87	H
C-C'	0.87	H

照明率表

天井	80%				70%				50%				30%				0%
	70%	50%	30%	10%	70%	50%	30%	10%	70%	50%	30%	10%	70%	50%	30%	10%	0%
壁	10%																0%
床	10%																0%
0.60	80	73	69	66	79	73	69	66	78	72	68	65	76	71	68	65	64
0.80	86	79	75	72	85	79	74	71	83	78	74	71	81	77	73	71	70
1.00	90	84	80	77	89	84	80	77	87	83	79	77	86	82	79	76	75
1.25	94	89	85	82	93	88	85	82	91	87	84	81	89	86	83	81	79
1.50	96	92	88	86	95	91	88	85	93	90	87	85	91	88	86	84	82
2.00	100	97	94	92	99	96	93	91	97	94	92	90	95	93	91	89	88
2.50	102	100	97	95	101	99	97	95	99	97	95	94	97	96	94	93	91
3.00	104	102	100	98	103	101	99	98	101	99	98	97	99	98	96	95	93
4.00	105	104	102	101	104	103	102	101	102	101	100	99	100	99	99	98	96
5.00	106	105	104	103	105	104	103	102	103	102	101	101	101	100	100	99	97
7.00	107	106	106	105	106	105	105	104	104	104	103	103	102	102	101	101	99
10.00	108	107	107	107	107	106	106	106	105	104	104	104	103	103	102	102	100