

屋内照明器具特性

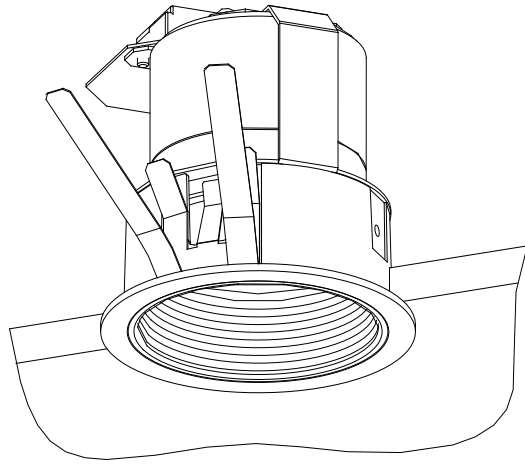

品名	DD-3564-LL		
光源	LED7.6W		
実効光束 (器具光束)	343lm	エネルギー 効率	47.1lm/W



配光曲線図
実光度

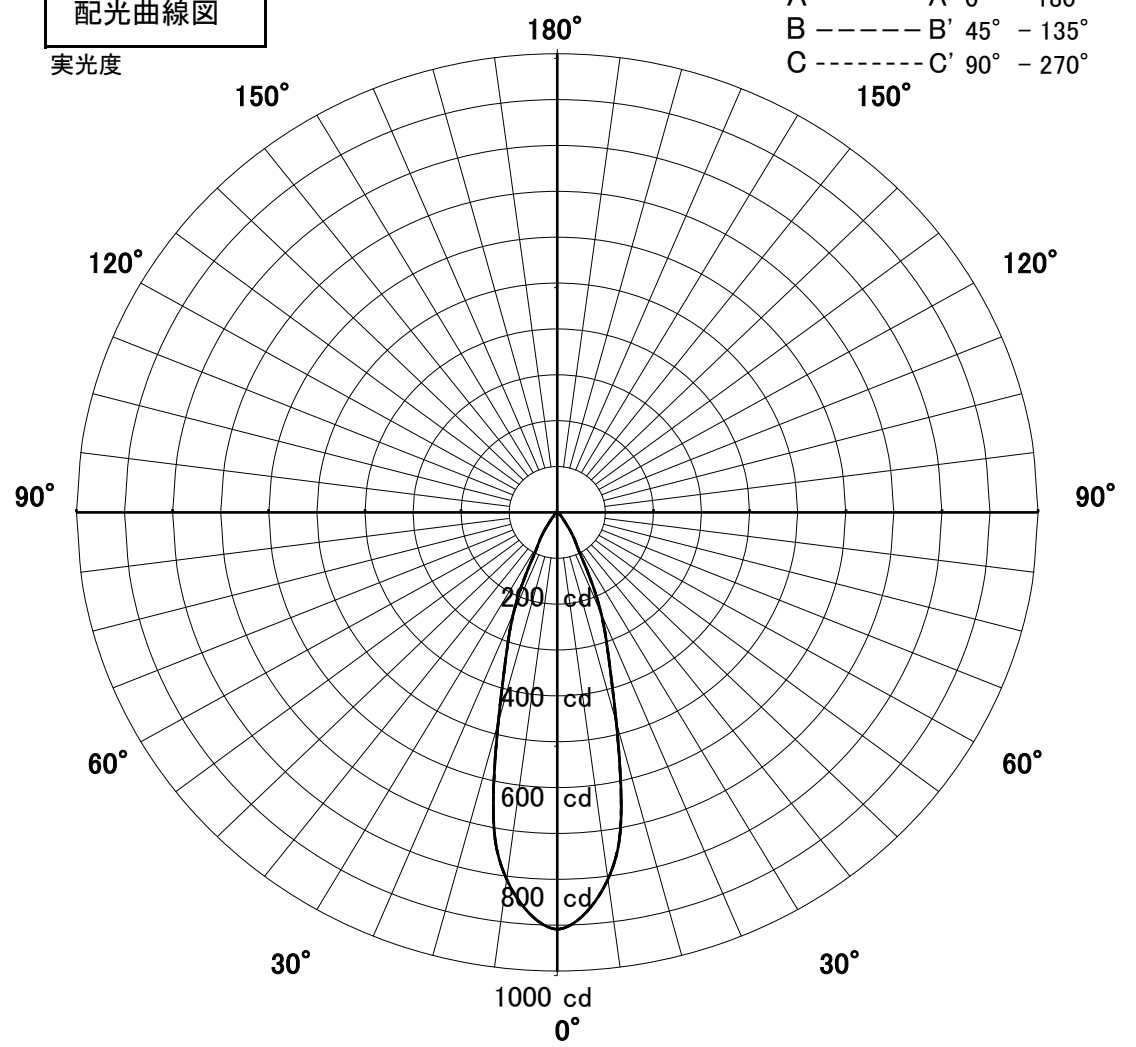

1/2照度角

直射水平面照度

単位: Lx

器具効率	70.3%	
色温度	2700K	
演色評価指数	Ra80	
保守率	良	0.67
	中	0.63
	否	0.56
1/2照度角		
A-A'	30.0	Deg
C-C'	30.0	Deg
最大取付間隔		
A-A'	0.54	H
C-C'	0.54	H

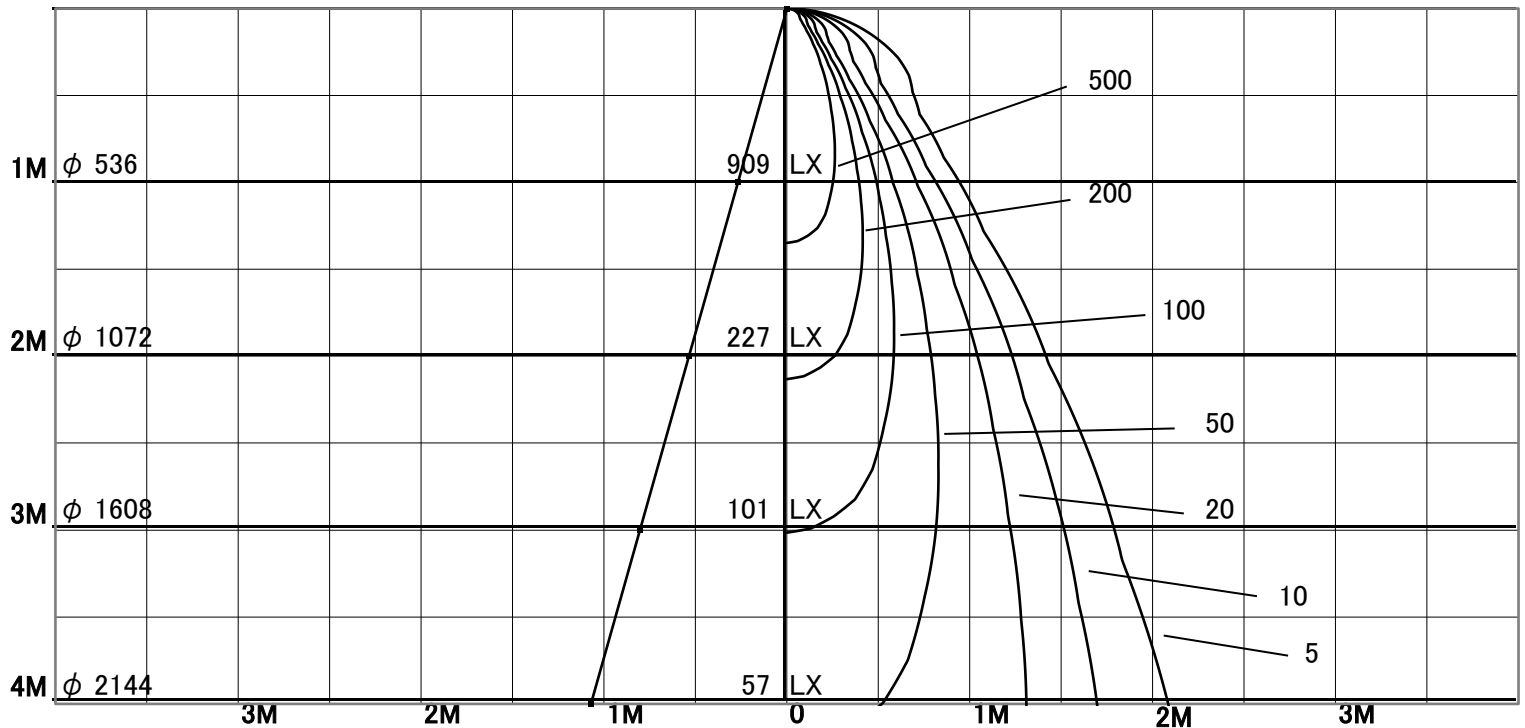

固有照明率表

	80%				70%				50%				30%				0%
	70%	50%	30%	10%	70%	50%	30%	10%	70%	50%	30%	10%	70%	50%	30%	10%	0%
天井	10%																0%
壁	10%																0%
床	10%																0%
0.60	85	79	75	72	84	78	74	72	83	78	74	72	82	77	74	71	70
0.80	90	84	80	77	89	84	80	77	88	83	79	77	86	82	79	76	75
1.00	94	89	85	82	94	89	85	82	92	87	84	82	90	86	84	81	80
1.25	98	93	89	87	97	92	89	86	95	91	88	86	93	90	87	85	84
1.50	100	96	93	90	99	95	92	90	97	94	91	89	95	93	90	88	87
2.00	104	100	98	96	102	100	97	95	101	98	96	94	99	97	95	94	92
2.50	106	103	101	99	105	102	101	99	103	101	99	98	101	99	98	97	95
3.00	107	105	104	102	106	104	103	102	104	103	102	100	102	101	100	99	97
4.00	109	107	106	105	107	106	105	104	105	105	104	103	104	103	102	102	99
5.00	109	108	108	107	108	107	107	106	106	106	105	104	104	104	103	103	101
7.00	110	110	109	109	109	109	108	108	107	107	107	106	105	105	105	105	102
10.00	111	111	110	110	110	110	109	109	108	108	108	107	106	106	106	106	103