

屋内照明器具特性

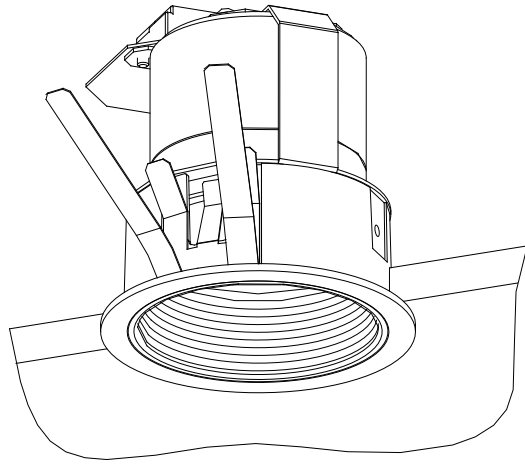

品名	DD-3665-LL		
光源	LED7.6W		
実効光束 (器具光束)	289lm	エネルギー 効率	39.5lm/W



配光曲線図
実光度

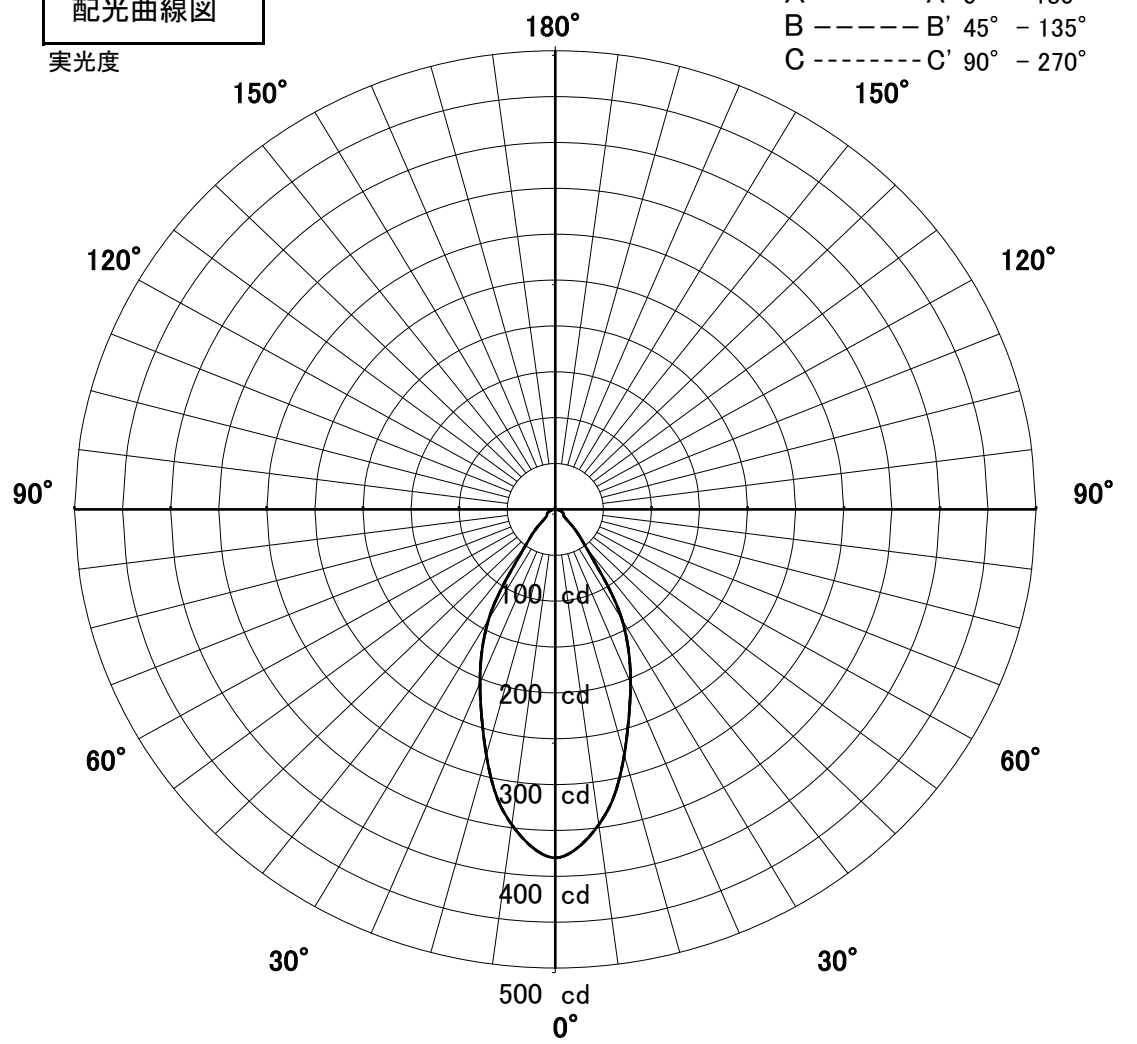

1/2照度角

直射水平面照度

単位: Lx

器具効率	59.2%	
色温度	2700K	
演色評価指数	Ra80	
保守率	良	0.67
	中	0.63
	否	0.56
1/2照度角		
A-A'	39.5	Deg
C-C'	39.5	Deg
最大取付間隔		
A-A'	0.72	H
C-C'	0.72	H

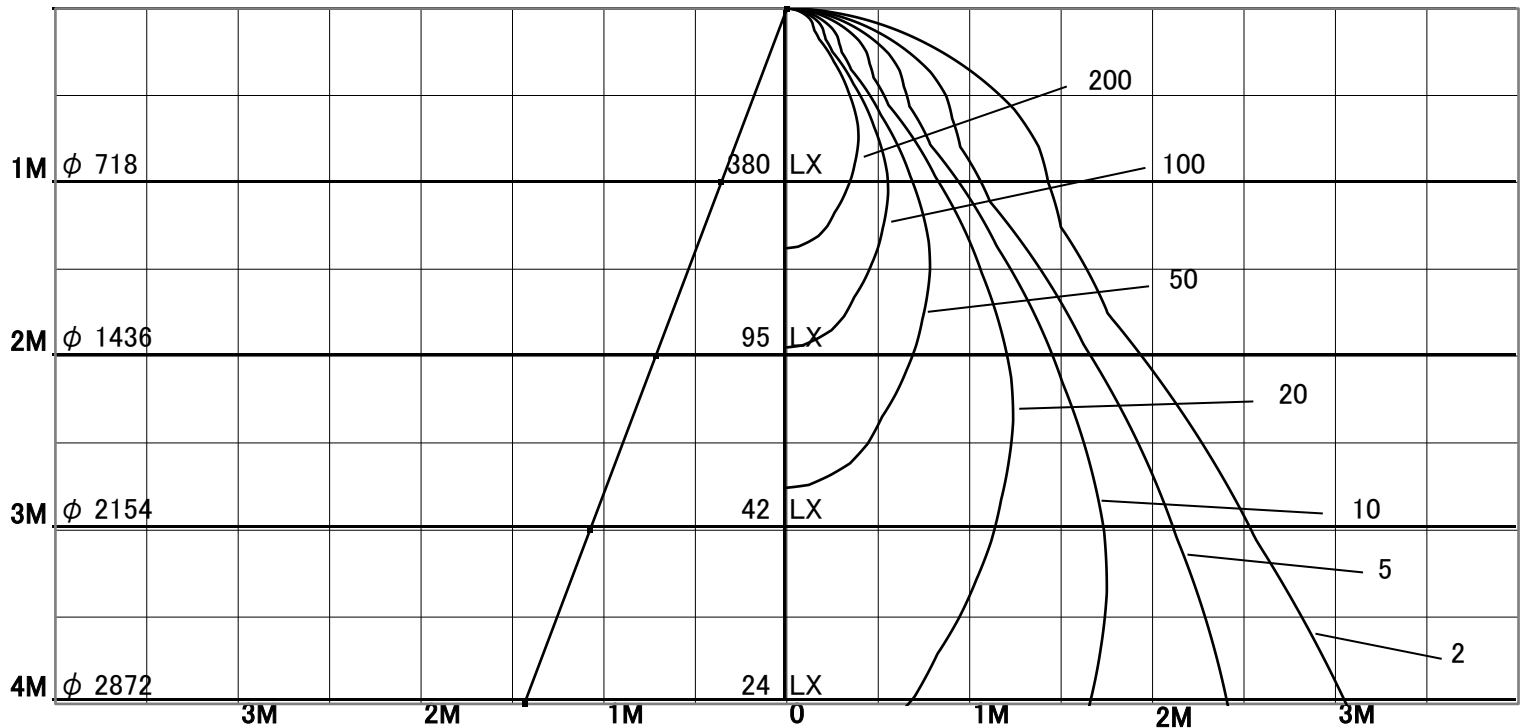

固有照明率表

天井	80%				70%				50%				30%				0%
	70%	50%	30%	10%	70%	50%	30%	10%	70%	50%	30%	10%	70%	50%	30%	10%	0%
壁	10%																0%
床	10%																0%
0.60	80	73	68	65	79	72	68	65	78	72	68	65	76	71	67	64	63
0.80	86	79	74	71	85	79	74	71	83	78	74	71	82	77	73	70	69
1.00	91	85	80	77	90	84	80	77	88	83	79	76	86	82	78	76	74
1.25	95	89	85	82	93	88	84	81	91	87	84	81	89	86	83	80	79
1.50	97	92	88	85	96	92	88	85	94	90	87	84	92	89	86	84	82
2.00	101	97	94	92	100	97	94	91	98	95	92	90	96	93	91	90	88
2.50	103	101	98	96	102	100	97	95	100	98	96	94	98	96	95	93	91
3.00	105	103	101	99	104	102	100	98	102	100	98	97	100	98	97	96	94
4.00	107	105	103	102	106	104	103	101	104	102	101	100	102	100	99	99	96
5.00	108	106	105	104	107	105	104	103	104	103	103	102	102	102	101	100	98
7.00	109	108	107	106	108	107	106	106	106	105	104	104	104	103	103	102	100
10.00	110	109	109	108	108	108	108	107	106	106	106	105	104	104	104	104	101